

A close-up photograph of a red, textured cushion. The cushion has gold-colored embroidery on it, which appears to be the letters 'JAY'. The lighting is warm, highlighting the texture of the fabric and the metallic sheen of the embroidery.

BACKS AND CUSHIONS

JAY[®]

WE'VE GOT YOUR BACK

(AND BACKSIDE)!

table of CONTENTS

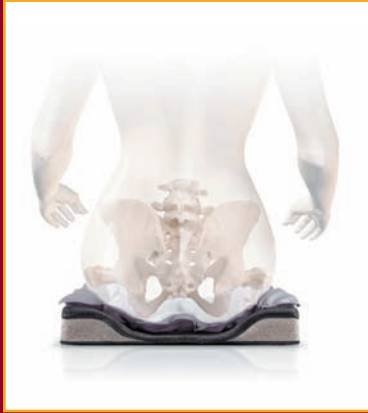

Cushions

- 1 Jay Basic E2601/E2602
- 1 Jay Soft Combi P E2605/E2606
- 2 Jay Triad E2603
- 3 Jay Care E2607
- 4 Jay Duo E2603
- 5 Jay Xtreme/Jay Xtreme S E2603
- 6 Jay Easy E2607
- 7 Jay J2 / Jay J2 Positioning K0734
Adjustable Skin Protection/Adj Skin Protection and Positioning
- 8 Jay J2 Deep Contour / Jay 2 Deep Contour Positioning
K0734 Adjustable Skin Protection/Adj Skin Protection and Positioning
- 9 SADMERC Code K0669:
 - Jay Combi/Soft Combi
 - Jay J-Gel
 - Jay Active
 - Jay GS PR
 - Jay J2 Plus
- 10 Modifications
- 11 Cushion Accessories and Specs

Backs

- 12 Jay Basic E2611
- 13 Jay Care E2615
- 14 Jay J2 E2613
- 15 Jay J2 Tall E2613
- 16 Jay J2 Deep Contour E2615
- 17 Jay Focus Point E2615
- 18 Jay J2 Plus E2614
SADMERC Code K0669:
 - Jay Xtreme
- 19 Jay Solid Seat
- 19 Jay Protector
- 20 Jay Precision K0108 Misc. Wheelchair Accessory
- 21 Back Accessories and Specs

CLINICAL (BASIC)

- Designed for the client who has symmetrical postures needing minimum postural support.
- Provides mild lateral stability as well as mild forward/rearward stability.
- Provides level base of support.

TECHNICAL (BASIC)

- Durable molded foam provides mild contouring.
- Beveled to fit between the seat rails on seat upholstery.
- Pre-contoured foam base encourages orthopedic alignment and helps to redistribute pressure to increase sitting tolerance.

POSTURE

- Most suitable for the client at low risk of skin breakdown / for the client with intact skin integrity.

SKIN

Jay Basic

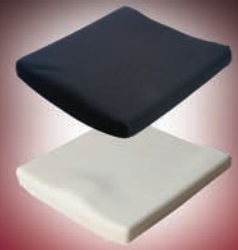

SADMERC Code:
E2601/E2602

CLINICAL (SOFT COMBI P)

- Designed for the client who has symmetrical postures needing minimum to moderate postural support.
- Provides mild lateral stability as well as mild to moderate forward/rearward stability.
- Provides a level base of support.

TECHNICAL (SOFT COMBI P)

- Pre-contoured foam bases features a deeper leg trough and increased medial thigh support.
- Provides trochanteric support to redistribute the load from the ischials.
- Optional solid seat insert.

POSTURE

- Most suitable for the client at low risk of skin breakdown / for the client with intact skin integrity.

SKIN

Soft Combi P

SADMERC Code:
2605/E2606

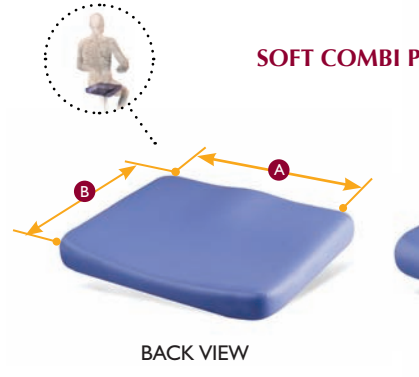
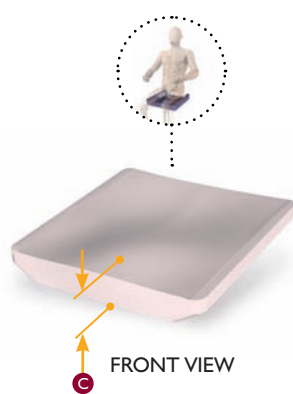
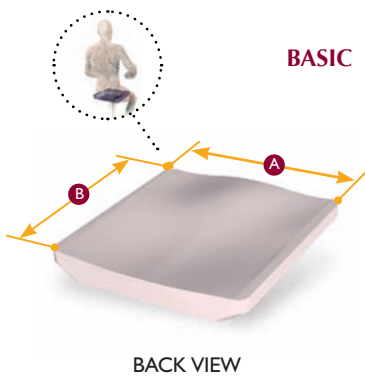
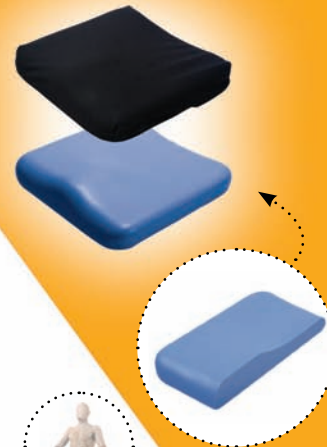

All listed measurements are in inches.

These cushions include a contoured foam cushion and black incontinence-resistant cover.

PART #	CHAIR SIZE	ACTUAL WIDTH	ACTUAL LENGTH	OVERALL HEIGHT	PART #	CHAIR SIZE	ACTUAL WIDTH	ACTUAL LENGTH	OVERALL HEIGHT
		A	B	C			A	B	C
300	19x16	18.63	16.00	2.50	2200P	18x16	18.00	16.00	3.13
301	18x18	17.63	18.00	2.50	2201P	18x18	18.00	18.00	3.00
305-MJ	16x16	15.63	16.00	2.50	2202P	20x18	20.00	18.00	3.25
306	16x18	15.63	18.00	2.50	2203P	18x20	18.00	20.00	3.00
308	14x16	15.63	14.00	2.50	2205P	16x16	15.50	16.00	3.25
309	20x18	20.00	18.25	2.50	2206P	16x18	15.50	18.00	3.00
320	22x20	21.63	20.00	2.50	2207P	16x20	16.00	20.00	3.13
328	22x20	21.63	20.00	2.50	2210P	14x14	14.00	14.00	3.25
340	24x20	23.63	20.00	2.50	2220P	22x20	21.50	19.81	3.07
348	24x18	23.63	18.00	2.50	2228P	22x18	21.50	17.75	3.07
356	15x16	14.63	16.00	2.50	2240P	24x20	23.50	19.75	3.07
376	17x16	16.63	16.00	2.50	2248P	24x18	23.50	17.69	3.07

JAY BASIC

SOFT COMBI P

Jay Triad & Triad P

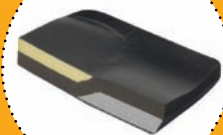

SADMERC Code:
Triad-E2603
Triad P-E2607

Includes a black, laminated neoprene incontinence-resistant cover and contoured foam base. Optional drop seat can be ordered by placing a "D" at the end of the part number (ex D1208D). The Triad P features increased medial thigh support.

CLINICAL

- ▶ Designed for the client who has symmetrical posture needing moderate postural support.
- ▶ Provides moderate lateral stability as well as moderate forward/rearward stability.
- ▶ Provides a level base of support.
- ▶ Triad P offers greater lateral stability and is ideal for the client that requires more positioning support.

TECHNICAL

- ▶ A firm, anatomically correct pre-contoured foam base creates a foundation for postural stability. The foam is closed cell and extremely lightweight.
- ▶ A second, supportive layer of foam placed over the foundation enhances posture and sitting tolerance.
- ▶ A third layer of visco-elastic foam in the pelvic area minimizes the elastic response of supporting foam layers.
- ▶ Beveled to fit between the seat rails on seat upholstery.
- ▶ Optional solid seat insert provides extra postural stability discouraging the cushion from slinging with the chair upholstery.
- ▶ Optional solid drop seat is permanently attached to the bottom of the cushion, replacing wheelchair upholstery, promoting a level-sitting platform when lower seat heights are required.

POSTURE

- ▶ Most suitable for the client at moderate risk of skin breakdown.
- ▶ Ideally the client can do a functional independent weight shift and has no history of decubitus ulcers.

- ▶ Pre-contoured foam, combined with visco-elastic (slow memory) foam promotes increased surface contact area for enhanced pressure distribution.
- ▶ The slow memory characteristic of the foam in the rear of the cushion improves the efficiency of independent weight shifts for the person at low to moderate risk for skin breakdown.

SKIN

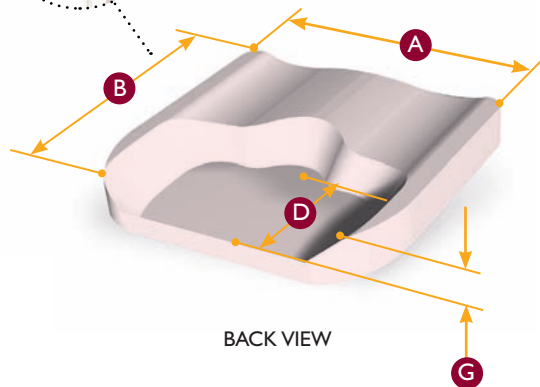

BACK VIEW

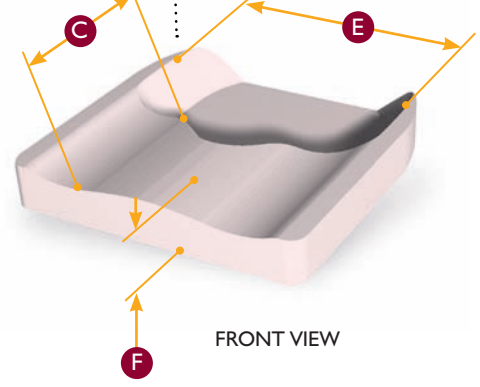

FRONT VIEW

Critical Dimensions for the Jay Triad and Triad P

PART #	CHAIR SIZE	ACTUAL WIDTH	ACTUAL LENGTH	FEMORAL SUPPORT LENGTH	PELVIC CONTOUR LENGTH	PELVIC CONTOUR WIDTH	OVERALL HEIGHT	UNLOADED WELL DEPTH
		A	B	C	D	E	F	G
1208-MJ	20x18	19.5	17.63	7.88	8	16.00	3.75	2
1266	16x16	15.5	15.63	6.88	7	11.75	3.75	2
1268	16x18	15.5	17.63	7.88	8	12.00	3.75	2
1286	18x16	17.5	15.63	6.88	7	14.25	3.75	2
1288	18x18	17.5	17.63	7.88	8	14.00	3.75	2
1208P	20x18	19.5	17.63	7.88	8	16.00	3.75	2
1266P	16x16	15.5	15.63	6.88	7	11.75	3.75	2
1268P	16x18	15.5	17.63	7.88	8	12.00	3.75	2
1286P	18x16	17.5	15.63	6.88	7	14.25	3.75	2
1288P	18x18	17.5	17.63	7.88	8	14.00	3.75	2

All listed measurements are in inches.

CLINICAL

- ▶ Most suitable for the sacral sitter.
- ▶ Designed for the client who has symmetrical posture needing moderate postural support.
- ▶ Provides moderate lateral stability as well as moderate forward/rearward stability.
- ▶ Provides a level base of support while being used on sling upholstery.

TECHNICAL

- ▶ The pre-contoured foam base provides a longer seat well to accommodate fixed “sacral sitting” where the ischials are positioned forward.
- ▶ The reinforced curved bottom counteracts the negative effects associated with sling upholstery providing a level sitting surface.

POSTURE



- ▶ Most suitable for the client at moderate risk of skin breakdown.
- ▶ Ideally the client can make a functional independent weight shift and there is no history of decubitus ulcers.

- ▶ The fluid Tripad™ incorporates left, right and rear sections to maintain the fluid under at-risk bony areas.

SKIN

SADMERC Code: Triad-E2603

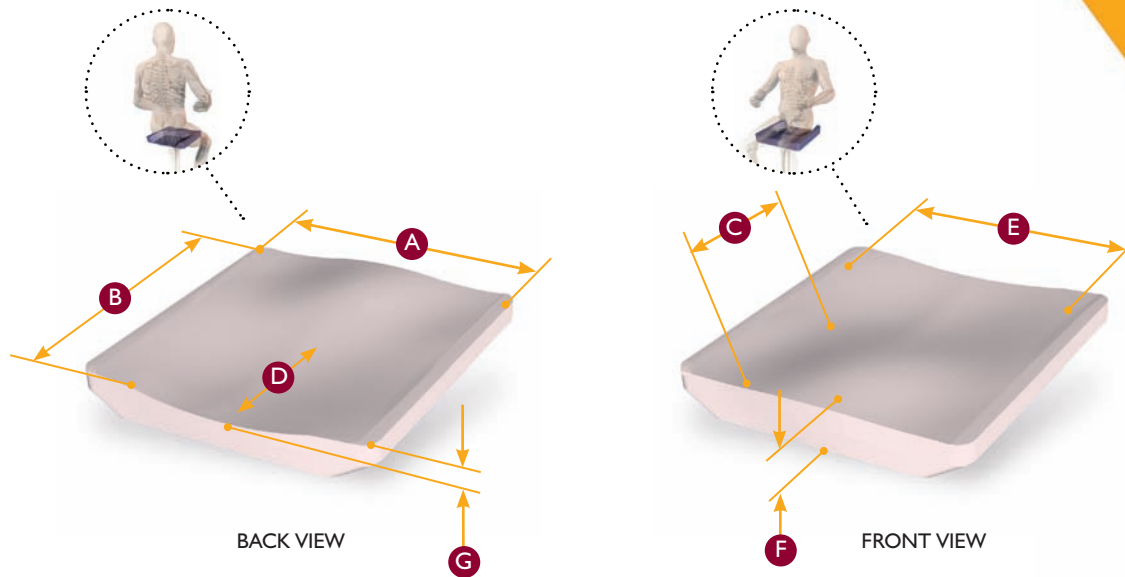

Includes a one-piece cushion, comprised of soft polyurethane foam base, a Jay Flow™ fluid pad for pressure reduction, and a reinforced, no-skid bottom all enclosed by an incontinence-resistant outer casing and covered with a washable stretch cover.

PART #	CHAIR SIZE	ACTUAL WIDTH	ACTUAL LENGTH	FEMORAL SUPPORT LENGTH	PELVIC CONTOUR DEPTH	PELVIC CONTOUR WIDTH	OVERALL HEIGHT	UNLOADED WELL DEPTH
		A	B	C	D	E	F	G
3100B	18x17.5	18.50	17.5	6.00	8.00	17.0	3.75	3.1
3101B	18x19.5	19.25	19.75	7.50	9.00	17.0	3.75	2.9
3105B	16x17.5	17.00	17.75	6.25	8.00	15.0	4.00	2.9
3106B	16x19.5	17.50	19.75	7.00	9.00	15.5	4.00	2.9
3109B	20x19.5	20.75	17.5	6.50	7.75	19.5	3.75	3.1

All listed measurements are in inches.

Jay Duo



SADMERC Code: E2603

CLINICAL

TECHNICAL

POSTURE

- ▶ Designed for the client who has symmetrical postures needing mild to moderate postural support.
- ▶ Provides mild lateral stability as well as mild to moderate forward/rearward stability.
- ▶ Provides a level base of support and promotes foot propelling and/or independent transfers.

- ▶ A lightweight, aluminum pre-contoured solid seat, in combination with a soft foam/fluid cushion replaces the sling upholstery.
- ▶ Provides an anatomically correct, stable base of support that promotes postural stability.
- ▶ Seat-to-floor height is maintained at seat rail height with the cushion in place.

SKIN

- ▶ Most suitable for the client at moderate risk of skin breakdown.
- ▶ Ideally the client can perform a functional independent weight shift and has not history of decubitus ulcers.

- ▶ The Jay Flow™ fluid pad reduces the effects of shearing on the ischial tuberosities.

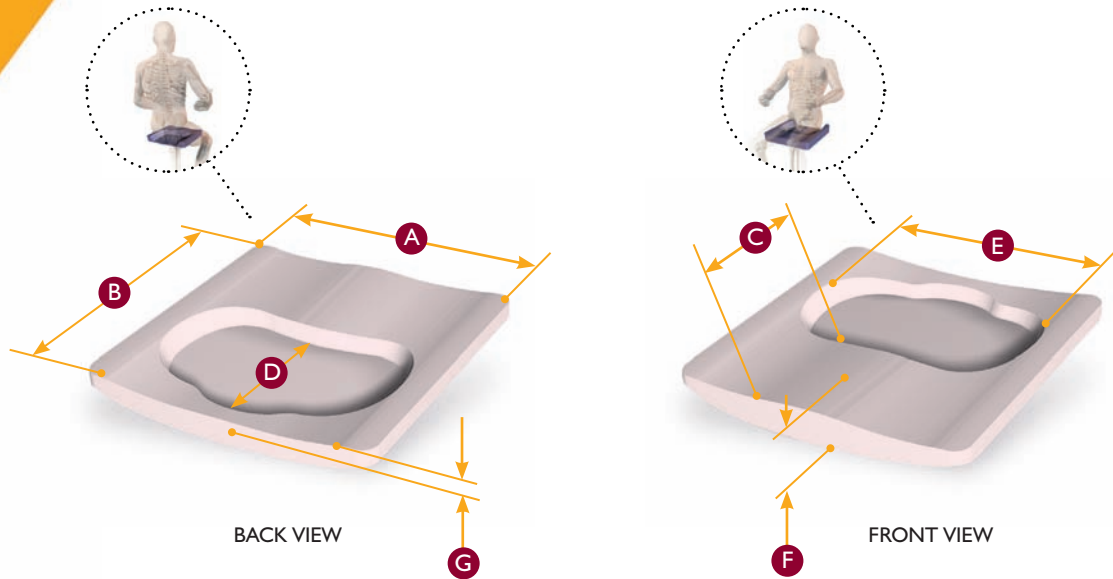

Includes a powder-coated aluminum contoured solid seat (with mounting hardware for both 7/8" and 1" seat rails), a wipeable polyurethane covered foam base, integral Jay Flow Fluid™ pad, and two black washable stretch covers.

Critical Dimensions for the Jay Duo

PART #	CHAIR SIZE	ACTUAL WIDTH	ACTUAL LENGTH	FEMORAL SUPPORT LENGTH	PELVIC CONTOUR LENGTH	PELVIC CONTOUR WIDTH	OVERALL HEIGHT	PELVIC CONTOUR DEPTH
		A	B	C	D	E	F	G
700	18x16	18.63	16.75	7.250	7.25	13.25	3.00	1.13
701*	18x18	18.00	18.88	8.500	8.25	13.00	3.50	1.13
705	16x16	16.00	16.75	7.625	7.25	11.50	3.81	1.31
706*	16x18	16.25	18.88	8.250	8.50	11.75	3.00	1.13
709*	20x18	20.63	18.88	8.250	8.50	14.75	3.13	1.13
776	17x16	17.25	16.75	7.875	7.75	12.50	3.00	1.25
778*	17x18	17.25	18.88	8.250	8.00	12.75	3.00	1.13
726	20x16	20.25	16.75	6.750	7.50	14.50	3.13	1.13

*Optional Q series pan modified for pop up footrests.

All listed measurements are in inches.

CLINICAL

- ▶ Designed for the active client who has symmetrical or mild asymmetrical posture needing minimum postural support.
- ▶ Provides mild lateral stability as well as mild forward/rearward stability.
- ▶ Provides a level base of support.

TECHNICAL

- ▶ The extremely lightweight, pre-contoured soft foam in combination with the optional half-solid seat insert provides a stable base of support.
- ▶ The additional adductors promote optimal thigh positioning.

POSTURE

- ▶ Most suitable for the client at moderate to high risk of skin breakdown.

- ▶ The stable base of support combined with the dynamic properties of Jay Flow™ fluid greatly reduces the effects of shear.

SKIN

Jay Xtreme & Xtreme S



SADMERC Code:
Xtreme and Xtreme S
E2603

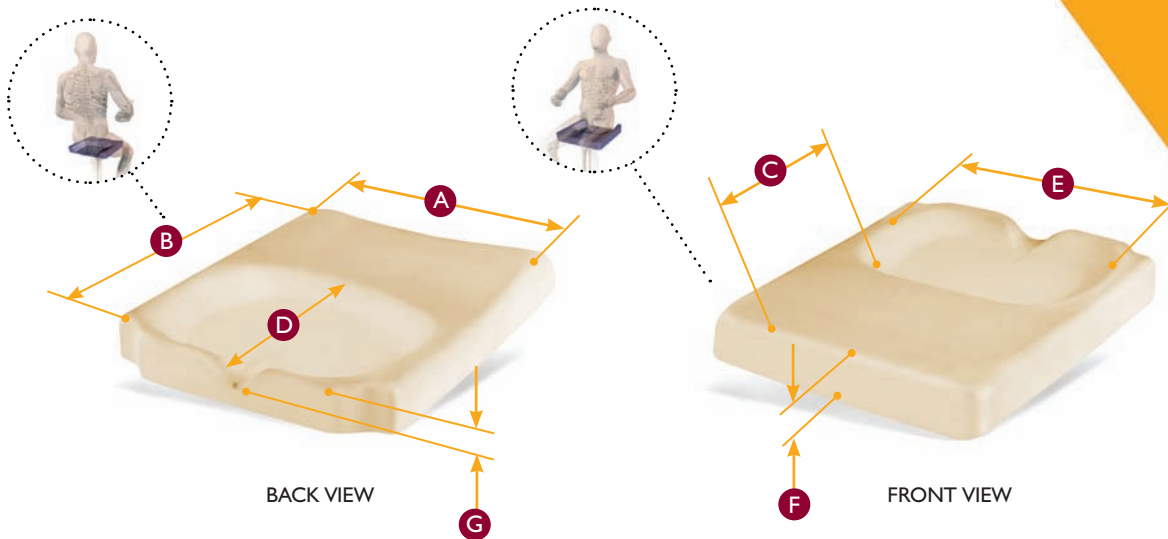

Includes a foam base, Jay Flow Fluid™ pad, lateral thigh supports, two Tritex™ (T) covers or two Low Shear™ (LS) covers “add cover selection to the end of the part number.” The Jay Xtreme S features an incontinent cover with an Easy-style sewn in pocket for the fluid pad; and no inside cover or adductors. To order the Xtreme S enter an “S” at the end of the part number (ex 944S).

Critical Dimensions for the Jay Xtreme and Xtreme S

PART #	CHAIR SIZE	ACTUAL WIDTH	ACTUAL LENGTH	FEMORAL SUPPORT LENGTH	PELVIC CONTOUR LENGTH	PELVIC CONTOUR WIDTH	OVERALL HEIGHT	PELVIC CONTOUR DEPTH
		A	B	C	D	E	F	G
944	14x14	13.75	15	4.75	5.50	12.00	2.13	1.25
946	14x16	13.75	17	7.00	5.50	12.00	2.13	1.25
955	15x15	14.75	16	6.25	5.50	13.75	2.25	1.25
956	15x16	14.75	17	7.25	5.50	13.50	2.25	1.25
966	16x16	15.75	17	7.75	4.69	13.50	2.13	1.25
967	16x17	15.75	18	6.75	6.75	13.25	2.25	1.25
968	16x18	15.75	19	8.00	6.50	13.50	2.25	1.25
976	17x16	16.75	17	6.50	6.25	14.50	2.25	1.25
977	17x17	16.75	16	7.00	6.50	14.25	2.25	1.25
986	18x16	17.75	17	6.50	6.25	14.75	2.25	1.25
988	18x18	17.75	19	8.25	6.25	13.50	2.25	1.25
960	16x20	15.75	21	10.25	7.00	13.50	2.25	1.25
980	18x20	17.75	21	10.50	7.00	13.50	2.25	1.25
900	20x20	19.75	21	9.50	8.00	16.50	2.25	1.25

All listed measurements are in inches.

Jay Easy



SADMERC Code: E2607

CLINICAL

TECHNICAL

POSTURE

- Designed for the client who has symmetrical or mild asymmetrical posture needing moderate postural support.
- Provides moderate lateral stability as well as moderate forward/rearward stability.
- Provides a stable base of support.

- The lightweight pre-contoured foam provides a stable base of support.
- The built-in medial and lateral thigh support promotes optimal thigh positioning.
- The curved base version counteracts the negative effects associated with sling upholstery providing a level sitting surface.
- The flat base version is for use with a seat pan or with the optional solid seat insert to provide extra postural stability while discouraging the cushion from slinging with the chair upholstery.

SKIN

- Most suitable for the client at moderate to high risk of skin breakdown.

- The Jay Flow™ fluid Tripad™ design assists in maintaining fluid under the at-risk bony areas.
- The Jay Flow™ fluid in combination with the foam base conforms to bony prominences, distributes pressure more evenly and reduces peak pressures.

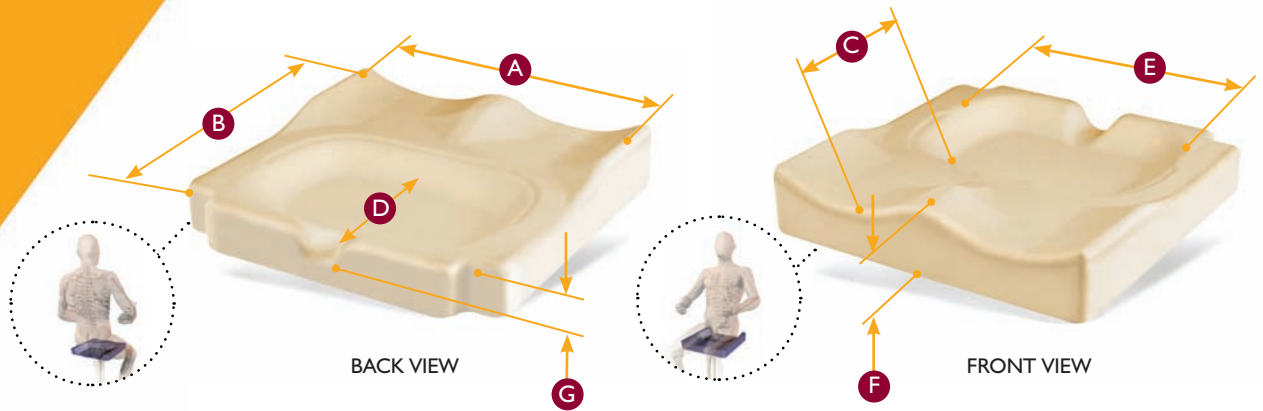

Includes a pre-contoured foam base (flat or curved), with Jay Flow Fluid™ pad and an incontinence-resistant cover.

PART #	CHAIR SIZE	ACTUAL WIDTH	ACTUAL LENGTH	FEMORAL SUPPORT LENGTH	PELVIC CONTOUR LENGTH	PELVIC CONTOUR WIDTH	OVERALL HEIGHT	PELVIC CONTOUR DEPTH
		A	B	C	D	E	F	G
JE1416 F/C	14 X 16	13.50	15.88	6.81	5.00	12.50	3.50	1.13
JE1418 F/C	14 X 18	13.50	17.88	8.81	5.00	12.50	3.50	1.13
JE1515 F/C	15 X 15	14.50	15.13	6.06	5.00	12.50	3.50	1.13
JE1516 F/C	15 X 16	14.50	16.13	7.06	5.00	12.50	3.50	1.13
JE1517 F/C	15 X 17	14.50	17.13	8.06	5.00	12.50	3.50	1.13
JE1615 F/C	16 X 15	15.50	15.50	5.81	5.00	14.00	3.50	1.13
JE1616 F/C	16 X 16	15.50	16.13	6.43	5.00	14.00	3.50	1.13
JE1617 F/C	16 X 17	15.50	17.00	7.31	5.00	14.00	3.50	1.13
JE1618 F/C	16 X 18	15.50	18.00	8.31	5.00	14.00	3.50	1.13
JE1715 F/C	17 X 15	16.25	15.13	5.56	5.00	14.00	3.50	1.13
JE1716 F/C	17 X 16	16.25	16.13	6.56	5.00	14.00	3.50	1.13
JE1717 F/C	17 X 17	16.25	16.88	7.31	5.00	14.00	3.50	1.13
JE1718 F/C	17 X 18	16.25	17.88	8.31	5.00	14.00	3.50	1.13
JE1816 F/C	18 X 16	17.50	16.00	6.31	5.00	14.00	3.50	1.13
JE1817 F/C	18 X 17	17.50	17.00	7.31	5.00	14.00	3.50	1.13
JE1818 F/C	18 X 18	17.50	18.00	8.31	5.00	14.00	3.50	1.13
JE1820 F/C	18 X 20	17.50	20.00	10.31	5.00	14.00	3.50	1.13
JE1916 F/C	19 X 17	18.50	15.88	6.31	5.00	14.00	3.50	1.13
JE1917 F/C	19 X 18	18.50	16.88	7.31	5.00	14.00	3.50	1.13
JE1918 F/C	19 X 19	18.50	17.88	8.31	5.00	14.00	3.50	1.13
JE1920 F/C	19 X 21	18.50	19.88	10.31	5.00	14.00	3.50	1.13
JE2016 F/C	20 X 16	19.50	15.88	6.31	5.00	15.00	3.50	1.13
JE2018 F/C	20 X 18	19.50	17.88	8.31	5.00	15.00	3.50	1.13
JE2020 F/C	20 X 20	19.50	19.88	10.31	5.00	15.00	3.50	1.13

Jay J2

CLINICAL

- Designed for the client who has moderate to more aggressive postural needs.
- Suitable for the client who may have changing postural needs over time.
- Provides excellent lateral stability as well as forward/rearward stability.
- Provides a stable base of support.

TECHNICAL

- A firm, anatomically correct pre-contoured foam base creates a foundation for postural stability. The foam is closed-cell and extremely lightweight.
- The base and fluid pad can be modified/customized on site to accommodate fixed postures or to correct flexible postures.
 - Modifications can support changing needs over time.
- Optional solid seat inserts provide extra postural stability discouraging the cushion from slinging with the chair upholstery.
- Postural accessories, such as medial and lateral thigh supports, lateral pelvic supports, and pelvic obliquity supports can be added to the cushion.

POSTURE



- Most suitable for the client who is at higher risk of skin breakdown and who has poor skin integrity.

- The Jay Flow™ fluid Tripad™ conforms to bony prominences, distributes pressure more evenly and reduces peak pressures.
- The Jay Flow™ fluid Tripad™ design assists in maintaining fluid under the at-risk bony areas.
- Optional J2 Recline Fluid Pad controls fluid migration to the rear of the seat well. Ideal for mild sacral sitters, those who transfer by scooting to the back of the chair or users of recline systems.

SKIN



SADMERC Code: K0734 adjustable cushion
If other positioning devices (exceeding 1" of postural support) are used a letter from CMS outlining billing practices can be reviewed at www.sunrisemedical.com

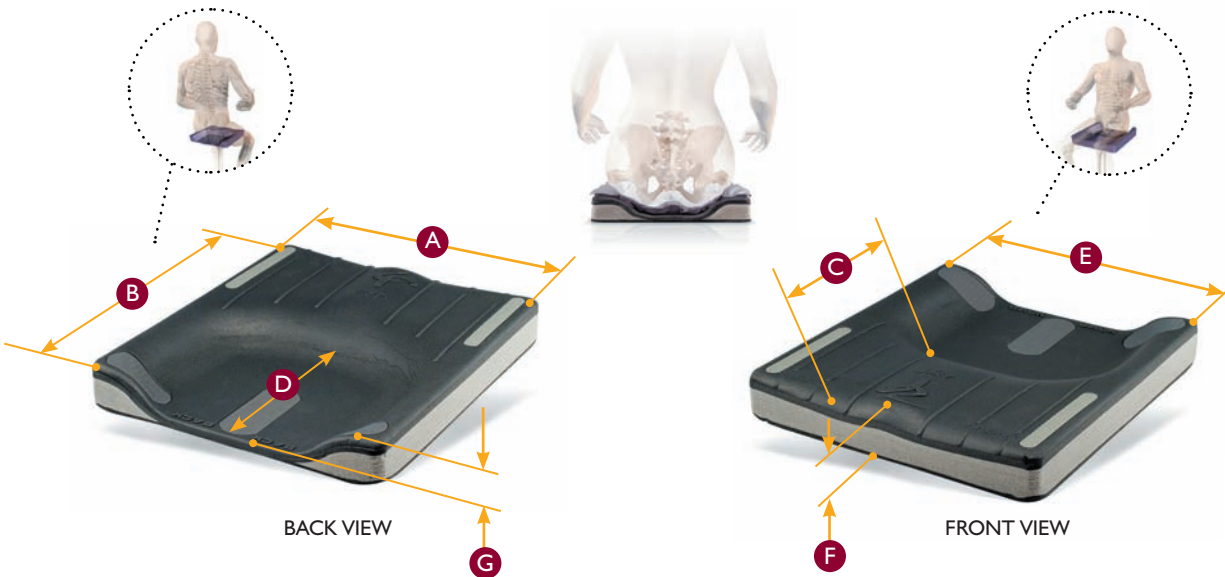

Includes a lightweight molded foam base and a Jay Flow™ pad and a ballistic-edged stretch cover. Optional covers: AirExchange™ (A) or incontinence-resistant cover (N) also available. To order a Jay J2 with a positioning device place a "P" at the end of the part number (ex 2100P).

PART #	CHAIR SIZE	ACTUAL WIDTH	ACTUAL LENGTH	FEMORAL SUPPORT LENGTH	PELVIC CONTOUR LENGTH	PELVIC CONTOUR WIDTH	OVERALL HEIGHT	PELVIC CONTOUR DEPTH
		A	B	C	D	E	F	G
2100-MJ	18x16	17.50	16.00	6.75	7.50	13.75	3	2.50
2101	18x18	17.50	18.00	7.75	8.00	13.75	3	2.50
2102-MJ	20x20	19.50	19.75	8.75	9.25	15.75	3	2.50
2103-MJ	18x20	17.50	20.00	8.25	9.00	14.00	3	2.50
2104-MJ	24x20	23.50	20.00	9.00	9.50	18.00	3	2.50
2105-MJ	16x16	15.75	16.00	6.25	7.63	11.88	3	2.63
2106-MJ	16x18	15.75	18.00	7.25	7.88	11.76	3	2.50
2107-MJ	16x20	15.50	20.00	8.50	9.00	11.76	3	2.50
2108	14x16	13.50	16.00	6.25	7.38	10.25	3	2.75
2116-MJ	20x16	19.50	15.75	6.75	7.500	15.88	3	2.63
2117-MJ	17x17	16.50	17.00	7.00	7.500	12.75	3	2.50
2118-MJ	20x18	19.50	18.00	7.50	7.88	15.88	3	2.50

To order the Recline Fluid Pad remove the "-MJ" from the part number and add a ".1" (Example: 2100.1).

All listed measurements are in inches.

Jay J2 Deep Contour



SADMERC Code: K0734 adjustable cushion
If other positioning devices (exceeding 1" of postural support) are used a letter from CMS outlining billing practices can be reviewed at www.sunrisemedical.com



POSTURE

- Designed for the client who has moderate to more aggressive postural needs.
- Provides excellent lateral stability as well as forward/rearward stability.
- Provides a stable base of support.
- A firm, anatomically correct deep contoured foam base creates a foundation for postural stability. The foam is closed-cell and extremely lightweight.
- The base and fluid pad can be modified/customized on site to accommodate fixed postures or to correct flexible postures.
 - Modifications can support changing needs over time.
- Optional solid seat inserts provide extra postural stability discouraging the cushion from slinging with the chair upholstery.
- Optional solid drop seat is permanently attached to the bottom of the cushion, replacing wheelchair upholstery, promoting a level-sitting platform when lower seat heights are required.

SKIN

- Most suitable for the client who is at the highest level of risk for skin breakdown or who has very poor skin integrity.
- The 3D Jay Flow™ fluid Tripad™ in combination with the softer foam overlay conforms to bony prominences, distributing pressure more evenly and reducing peak pressures.
- The 3D Jay Flow™ fluid Tripad™ design assists with maintaining fluid under the at-risk bony areas.



Includes an ultra-lightweight, pre-contoured foam base, a pre-contoured deep immersion 3D Jay Flow™ Tripad™, and a zipper enclosed ballistic-edged cover. Optional drop seat can be ordered by placing a "D" at the end of the part number (ex D1208D). To order a Jay J2 with a positioning device installed place a P at the end of the part number."

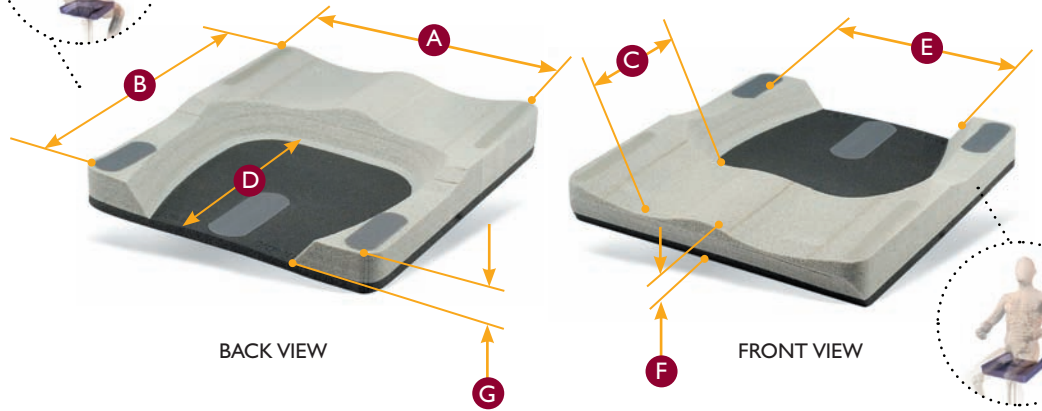

PART #	CHAIR SIZE	ACTUAL WIDTH	ACTUAL LENGTH	FEMORAL SUPPORT LENGTH	PELVIC CONTOUR LENGTH	PELVIC CONTOUR WIDTH	OVERALL HEIGHT	PELVIC CONTOUR DEPTH
		A	B	C	D	E	F	G
2400-MJ	20x20	19.75	19.75	7.25	10.625	18.00	4	3
2406	20x16	19.75	15.75	5.25	8.625	18.50	4	3
2408	20x18	19.75	17.75	6.25	9.750	19.38	4	3
2426	22x16	21.75	15.75	5.25	8.625	20.25	4	3
2428	22x18	21.75	17.75	6.25	9.750	21.63	4	3
2444	14x14	13.75	13.75	4.75	7.625	11.75	4	3
2446	14x16	13.75	15.75	5.75	8.625	12.50	4	3
2448	24x18	23.75	17.75	6.25	9.750	23.50	4	3
2455	15x15	14.75	14.75	5.13	8.000	13.00	4	3
2457	15x17	14.75	16.75	6.00	9.125	13.88	4	3
2460	16x20	15.75	19.75	7.50	10.500	14.25	4	3
2466	16x16	15.75	15.75	5.50	8.500	14.50	4	3
2468	16x18	15.75	17.75	6.38	9.500	15.38	4	3
2475	17x15	16.75	14.75	4.75	8.000	15.25	4	3
2477	17x17	16.75	16.75	5.88	9.125	16.00	4	3
2480	18x20	17.75	19.75	7.50	10.625	16.38	4	3
2486	18x16	17.75	15.75	5.38	8.625	16.50	4	3
2488	18x18	17.75	17.75	6.63	9.500	16.13	4	3

All listed measurements are in inches.

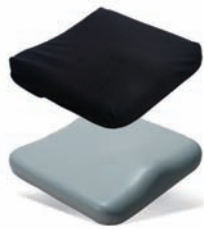

SADMERC Code K0669

Jay Combi/Soft Combi

These cushions include a contoured foam cushion and black incontinence-resistant cover.

Omit "B" from beginning of part number to receive both the cushion and lumbar support.

PART # COMBI	PART # SOFT COMBI	CHAIR SIZE
B200NB	B2200	18x16
B201NB	B2201	18x18
B202NB	B2202	20x18
B203NB	B2203	18x20
B205NB	B2205	16x16
B206NB	B2206	16x18
B207NB	B2207	16x20
B210NB	B2210	14x14
B215NB	B2215	12x12



SADMERC Code K0669

Jay J-Gel

Includes a contoured foam cushion, gel overlay and a Low Shear™ cover.

PART #	CHAIR SIZE	PART #	CHAIR SIZE
4206LS	20x16	4270LS	17x20
4208LS	20x18	4276LS	17x16
4246LS	14x16	4278LS	17x18
4248LS	14x18	4280LS	18x20
4260LS	16x20	4286LS	18x16
4266LS	16x16	4288LS	18x18
4268LS	16x18		



SADMERC Code K0669

Jay Active

Includes a foam base with a Jay Flow™ Fluid pad and 1" adductor wedges. All cushions come standard with an AirExchange™ Cover (incontinence resistant covers may be purchased on these cushion in lieu of the standard Air Exchange cover for the same price.)

Photo shown with Pressure Relief Pad

PART #	CHAIR SIZE
120	18x16
121	18x18
122	20x18
123	18x20
125	16x16
126	16x18
127	16x20
128	14x16



SADMERC Code K0669

Jay GS PR Pressure Relief

Includes a reinforced ABS shell with molded foam back insert, back wedge, lumbar shim, quick-release mounting hardware, and an AirExchange™ cover. For optional permanent mounting hardware add an "R" to the end of the part number.

PART #	CHAIR SIZE
11100N	18x17-20
1105N	16x19
1110N	14x17
1115N	12x15
1111N	10x13



SADMERC Code K0669

Jay J2 Plus

Includes a pre-contoured cushion base with a foam overlay and a seat well that contains either a Jay Flow™ fluid pad (FL) or a foam insert (FM) and an AirExchange™ cover. For the optional incontinence-resistant cover replace the "A" with an "N" in the part number.

PART #	CHAIR SIZE	PART #	CHAIR SIZE
302018A	20x18	302418A	24x18
302020A	20x20	302420A	24x20
302022A	20x22	302422A	24x22
302218A	22x18	302618A	26x18
302220A	22x20	302620A	26x20
302222A	22x22	302622A	26x22

Modification

	REASON	Basic	Combi	Triad	J-Gel	Care	Duo	Xtreme	Active	Easy	J2	J2 Deep Contour	GS	J2 Plus
Well Sizing Example: Trochanteric width = 16", Wheelchair Size = 18" x 18". Order an 18" x 18" cushion with a well size of 16" (i.e. 2488 with a 2468 well size).	Used when the appropriate sized cushion's well contours do not provide the ideal size for the user. Allows the use of the well size of one cushion and the dimensional size of another.										●	●	●	
Overfills	If the client bottoms out in a regular pad - to protect skin.							●		●	●	●	●	●
Under fill	To increase immersion of the buttocks when there is no concern for bottoming out.							●	●			●	●	●
Obliquity Overfill	If client bottoms out in a regular pad to protect skin. To build up one side in the case of a flexible obliquity.							●	●	●	●	●	●	●
Obliquity Under fill	When there is no concern of bottoming out and a need to lower one side of the pelvis as in the case of an obliquity.							●	●			●	●	●
Scoop / Leg Trough Cut	To accommodate prosthesis in case of amputation. To allow for open hip angle. To get the seat-to-floor height lower on one or both sides.		●	●				1" max	●	1" max	●	●	●	●
Leg Length Discrepancy Cut	Accommodates leg length discrepancies. Accommodates posterior dislocated hips. Accommodates prosthetic devices. Accommodates fixed pelvic rotations.	●	●						●	●	●	●	●	●
Contracture Cuts	Tight hamstrings / foot propulsion.	●	●	●				●	●	●	●	●	●	
Medial Thigh Support Cut	Allow thighs to be positioned in a wind swept position to facilitate transfers.		●	●	●						●		●	
Notch for Seat Rails	Needed when using a cushion with a solid drop seat – allows the cushion to sit down and between the seat rails.	●	●	●	●			●	●		●	●	●	
Notch for Back Post	Growth considerations - getting the cushion back far enough when a back support adds seat depth and locking in cushion in the case of multiple transfers.	●	●					●	●	●	●	●	●	●
Increased Length	If a longer femoral loading area is required for stability, leg positioning or pressure distribution without sacrificing ischial positioning in the well, additional base length may be required.										up to 4"	up to 4"	up to 4"	
Reduced Length	When a shorter femoral loading area is required, while the pelvis may need longer well dimensions. Example, a person with a bilateral, above-knee amputation may need the full size well of an 18" deep cushion, however may only need a very short femoral loading area. An order would be placed for an 18" deep cushion cut back to 16" depth.							up to 4"	up to 4"	up to 4"	up to 5"	up to 4"	up to 4"	
Increased Width	May be necessary when accommodating the smaller pelvic/bony dimensions in a person with increased /wider soft tissue dimensions. Example – trochanteric width = 15" but overall widest dimension = 19". Then an order would be placed for a 16" cushion built out to 19" overall width.										up to 6"	up to 6"	up to 4"	
Reduced Width	May be requested when the wheelchair is being kept as narrow as possible and trimming the width of the cushion provides a better fit with clearance for the arm supports or clothing guards without compromising pelvic contours. May also be requested when the size required is not a standard offering, e.g. 15", 19" etc.	up to 1"	up to 2"	up to 2"	up to 1"			up to 1"	up to 1"	up to 1"	up to 2"	up to 1"	up to 1"	
Increase Height	To increase seat height to accommodate leg length and/or transfers.										up to 3"	up to 3"	up to 3"	
Angle Wedge	To be used under the prescribed cushion to open or close client hip angle – wheelchair seat-to-back angle.	●	●	●	●			●	●	●	●	up to 1"	●	
Custom Modification	When any modification other than listed is required for unique circumstances.	●	●	●	●	●	●	●	●	●	●	●		
Custom Drop Seat Cut	When other than standard solid drop seat sizes are required.			●								●	●	

Cushion Accessories and Specs

	BASIC	COMBI	TRIAD	J-GEL	CARE	DUO	XTREME	ACTIVE	EASY	J2	J2 DC	GS PR	J2 PLUS
JAY BOX OF ACCESSOIRES													
• Complete Box (155)													
• 2" Adductor Wedge (B113)								•	•	•	•		
• 1.5" Base Wedge (B114)													
• 1" Adductor Wedge (pair) (B119)								•	•	•	•		
• 2" Abductor Wedge (pair) (B118)								•	•	•	•		
• Child Adductor Wedge (B163)												•	
• 2" Junior Abductor Build Up (B168)												•	
• 2" Hip Guides (B1167)	•	•	•	•	•	•	•	•	•	•	•	•	•
• Mini fluid supplement pad (F119)	•	•	•	•	•	•	•	•	•	•	•	•	•
J2 PLUS INSERTS													
• Foam Kit (Standard: 300018-MJ, 300020-MJ, 300022-MJ) (Custom: 300118-MJ, 300120-MJ, 300121-MJ)													•
• Fluid Pad (Custom: 300118-MJ, 300120-MJ, 300121-MJ)													•
DROP HOOK OPTIONS (SET OF FOUR):													
• 1/2" (M-24S)			•									•	
• 1" (M-24S)			•									•	
• 1 1/2" (M-24L)			•									•	
MISCELLANEOUS:													
• Solid Seat Insert (S105)		•	•	•			•	•	•	•	•		
• Solid Drop Seat			•								•		
• Aluminium Seat Pan						•							
• Pelvic Obliquity Build-up 1/2" (B21160, 21170, 2177)										•	•		
• Pressure Relief Pad (F1100.1-18x20, F1105.1-16x19, F1110.0-14x17, F1111-10x13, F1115.1-12x15)												•	
• Lumbar Support Combi: 2250 (Adult), 2251 (Jr) Soft Combi: 250XB (Adult), 251XB (Jr)	•	•	•	•									
• 2" hip guides (F119)												•	
• Mini fluid supplement pad (F119)		•										•	
• Retaining Clips: 1" and 7/8" (M727-1", M723 - 7/8")					•								
• 1/2" well build up													
• Pre-ischial shelf extender (B1171-10x13, B1173-12x15, B1174-14x17, B1175-16x19, B1176-18x20)												•	
• Rubber Bumper (M726) not available on the Triad.						•							
COVERS:													
• Wipeable		•	•	•	•	•	•	•	•	•	•	•	•
• Embroidery		•	•	•	•	•	•	•	•	•	•	•	•
• Cover Colors		•	•	•	•	•	•	•	•	•	•	•	•
• Ballistic Stretch				•	•	•					•		
• AirExchange™					•	•		•	•	•	•	•	
• Incontinence	•	•			•	•		•			•	•	
• Low Shear Incontinence-Resistant				•				•			•		
• Front Handle				•				•			•		•
• Custom	•	•	•	•	•	•	•	•	•	•	•	•	•
• User Weight Capacity (lbs.)	250	250	250	250	250	250	250	250	250	250	250	250	650
• Warranty (years)	1	5	2	2	2	2	2	2	2	2	2	2	2

Jay Basic Back



SADMERC Code: E2611

Includes an light weight aluminum shell, foam, both a 0° and 8° top mounting hook and the choice of clamp or strap style hardware.

THORACIC

- ▶ Designed for the client with mild postural needs.
- ▶ Provides mild posterior pelvic-stabilization.
- ▶ Provides mild thoracic support.
- ▶ Facilitates thoracic extension.

LATERAL

- ▶ Provides mild lateral support.

TECHNICAL

- ▶ Three height options provide a more personalized fit.
- ▶ Lightweight for improved propelling efficiency and ease of transport.
- ▶ Lightweight, contoured, aluminum shell and soft foam-insert
- ▶ Creates minimal loss of seat depth.

Effects to seat depth with relation to recline (8° reclined hook).

L	M	N
8°	1.15	1.52

Effects to seat depth with relation to recline (vertical hook).

L	M	N
0°	-0.89	0.89

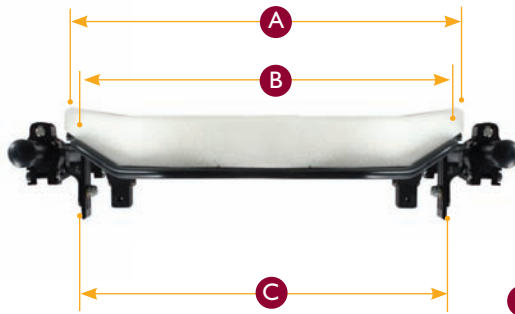

TOP VIEW

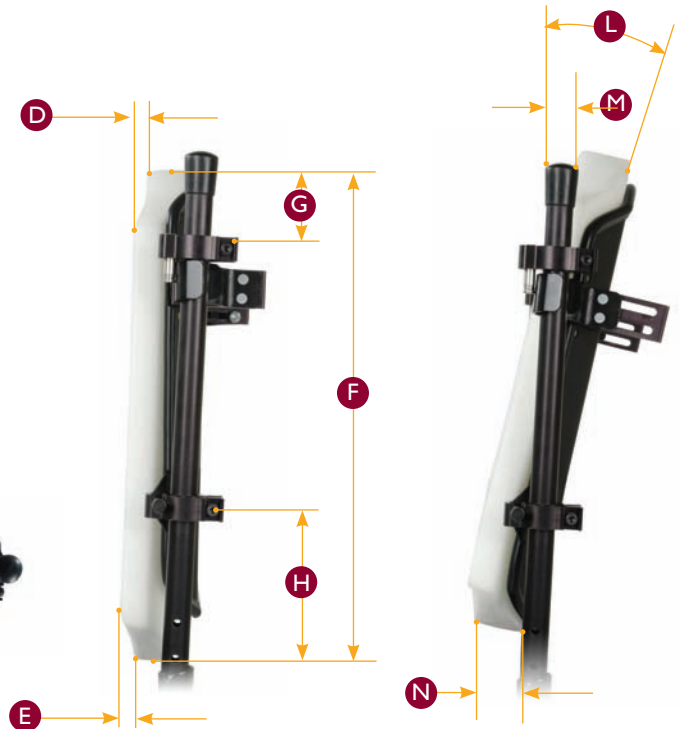

SIDE VIEW

SIDE VIEW - RECLINED

Add FS to the suffix of the part number to request strap (J2) style hardware, or FC to request the new clamp style hardware. Example 3346FS

PART #	OUTSIDE WIDTH OF SHELL	WIDTH OF SUPPORT SURFACE	ATTACHING WIDTH FOR CHAIRS	UPPER CONTOUR DEPTH OF BACK	LOWER CONTOUR DEPTH OF BACK	HEIGHT OF BACK SHELL	UPPER ATTACHMENT POINT	LOWER ATTACHMENT POINT
	A	B	C	D	E	F	G	H
3346 FS/FC	11.50	10.88	11.47-13.30	0.38	0.38	17.50	4.74-6.00	3.49-5.40
3348 FS/FC	11.50	10.88	11.47-13.30	0.38	0.38	19.50	6.74-8.00	3.49-5.40
3340 FS/FC	11.50	10.88	11.47-13.30	0.38	0.38	21.50	8.74-10.00	3.49-5.40
3366 FS/FC	13.50	12.88	13.47-15.30	0.38	0.38	17.50	4.74-6.00	3.49-5.40
3368 FS/FC	13.50	12.88	13.47-15.30	0.38	0.38	19.50	6.74-8.00	3.49-5.40
3360 FS/FC	13.50	12.88	13.47-15.30	0.38	0.38	21.50	8.74-10.00	3.49-5.40
3386 FS/FC	15.50	14.88	15.47-17.30	0.38	0.38	17.50	4.74-6.00	3.49-5.40
3388 FS/FC	15.50	14.88	15.47-17.30	0.38	0.38	19.50	6.74-8.00	3.49-5.40
3380 FS/FC	15.50	14.88	15.47-17.30	0.38	0.38	21.50	8.74-10.00	3.49-5.40
3306 FS/FC	17.50	16.88	17.47-19.30	0.38	0.38	17.50	4.74-6.00	3.49-5.40
3308 FS/FC	17.50	16.88	17.47-19.30	0.38	0.38	19.50	6.74-8.00	3.49-5.40
3300 FS/FC	17.50	16.88	17.47-19.30	0.38	0.38	21.50	8.74-10.00	3.49-5.40

All listed measurements are in inches.

CLINICAL

- Designed for the client who has a fixed kyphotic posture.
- Provides a solid back support to accommodate existing deformity and helps slow down further deformity.
- Provides excellent posterior pelvis stabilization and posterior thoracic support.
- Accommodates thoracic kyphosis.
- Suitable also for the client who has changing postural needs over time. Addresses the needs of the client with skin integrity issues on the spinous processes.
- Accommodates the kyphotic trunk and hyper-extended neck to allow increased visual orientation, improved swallowing and improved wheel access for more efficient mobility.

TECHNICAL

- The contoured design and the 39° angle adjustability accommodates the multiple needs for the kyphotic client.
- Durable molded shell with a soft-segmented foam insert provides firm support, contours to the kyphotic spine and promotes posterior pelvic stabilization.
- Soft-segmented foam contours to the kyphotic spine and reduces peak pressure points.

Jay Care



SADMERC Code: E2615

Includes an ABS plastic back shell, soft segmented contoured back foam, built-in lateral support and universal mounting hardware.

THORACIC

LATERAL

- Provides mild to moderate lateral support, which promotes lateral stability, upper extremity function and increased sitting tolerance.
- Built-in lateral contour in the shell and soft-segmented foam insert.
- Foam wedges provide an opportunity for a more customized fit.

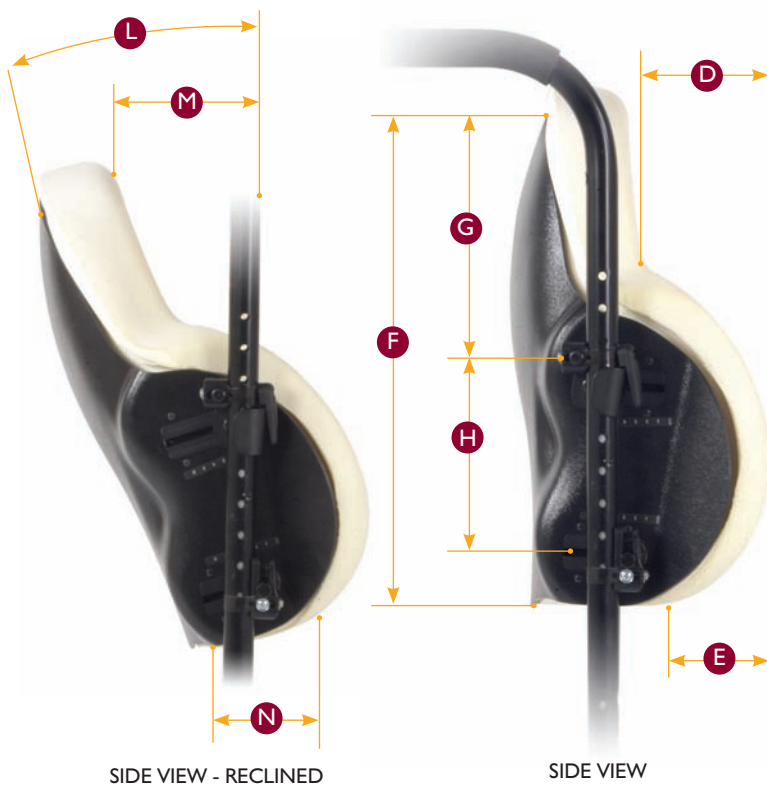

Effects to seat depth with relation to recline.

L	M	N
0°	-.38	.00
6°	.80	.48
12°	1.97	.96
18°	3.14	1.45
24°	4.32	1.93
30°	5.49	2.41
36°	6.66	2.89

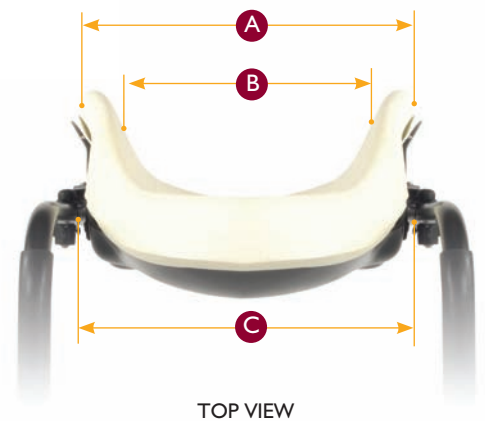

TOP VIEW

PART NUMBER	BACK SIZE	OUTSIDE WIDTH OF SHELL	WIDTH OF SUPPORT SURFACE	ATTACHING WIDTH FOR CHAIRS	UPPER CONTOUR DEPTH OF BACK	LOWER CONTOUR DEPTH OF BACK	HEIGHT OF BACK SHELL	UPPER ATTACHMENT POINT	LOWER ATTACHMENT POINT
		A	B	C	D	E	F	G	H
3500B	17-18	17.5	13.5	15.75	4.25	5.00	17.25	9.00	6
3502B	19-20	19.5	14.5	17.75	4.00	4.00	19.00	10.75	6
3505B	15-16	16.0	11.5	13.50	4.19	4.13	16.50	8.00	6

All listed measurements are in inches.

Jay J2



SADMERC Code: E2613

Includes a back shell, foam back, two lumbar shims, universal mounting hardware and an AirExchange™ cover.

CLINICAL

TECHNICAL

THORACIC

- ▶ Designed for the client who has minimal to moderate postural needs.
- ▶ Suitable for the client who has changing postural needs over time.
- ▶ Provides excellent posterior pelvis stabilization and posterior thoracic support, facilitating thoracic extension.
- ▶ Addresses the needs of the client with skin integrity issues on the spinous process.

- ▶ Lightweight, contoured aluminum shell and contoured foam insert.
- ▶ Angle adjustability of up to 15°.
- ▶ Optional spinal fluid pad insert provides pressure and shear reduction.
- ▶ Height adjustable.
- ▶ Creates minimal loss of seat depth.
- ▶ Shape and size minimizes interference with upper extremity functional activities.

LATERAL

- ▶ Provides mild to moderate lateral support.
- ▶ Optional fixed or swing-away trunk supports ideal for correcting or accommodating a mild to moderate asymmetrical posture.
- ▶ Optional fixed or swing-away trunk supports also ideal for providing symmetrical lateral support.

- ▶ Extended and offset hardware kits are available for a custom fit.
- ▶ Flat and curved pads available.
- ▶ Fluid pads available for the client with skin integrity issues.

Effects to seat depth with relation to recline (standard hooks).

L	M	N
-3°	0.00	1.50
0°	0.42	1.34
3°	0.85	1.18
6°	1.27	1.01
9°	1.70	0.85
12°	2.13	0.69

Effects to seat depth with relation to recline (long hooks).

L	M	N
7°	2.31	0.63
10°	2.74	0.45
13°	3.16	0.27
16°	3.59	0.10
19°	4.01	-0.08
22°	4.44	-0.25

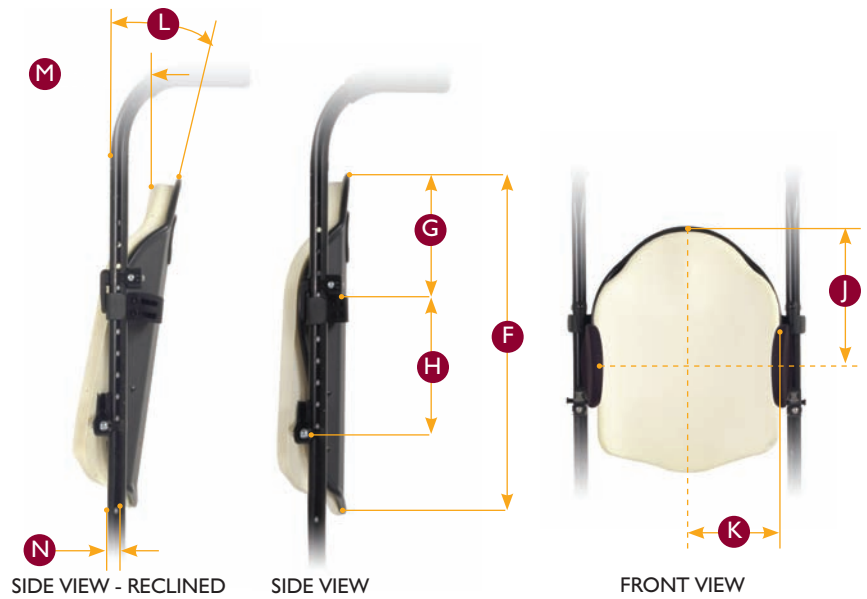
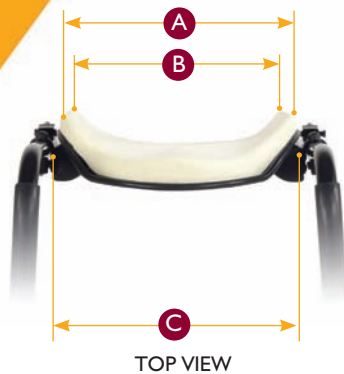

PART #	OUTSIDE WIDTH OF SHELL	WIDTH OF SUPPORT SURFACE	ATTACHING WIDTH OF CHAIRS	UPPER CONTOUR DEPTH OF BACK	LOWER CONTOUR DEPTH OF BACK	HEIGHT OF BACK SHELL	UPPER ATTACHMENT POINT	LOWER ATTACHMENT POINT	VERTICAL LATERAL SUPPORT POSITION	HORIZONTAL LATERAL SUPPORT POSITION
	A	B	C	D	E	F	G	H	J	K
2512K	8.63	8.50	9.25-10.25	1.75	1.250	12.63	3.625	5.25	5.63-9.63	4.00-5.50
2513K	9.50	10.00	10.18-11.13	1.75	1.000	13.00	4.000	5.25	5.63-9.63	4.50-6.00
2514K	11.00	10.75	11.25-12.25	1.75	1.250	14.50	5.125	5.25	5.63-11.63	4.75-6.25
2515K	11.75	12.00	12.25-13.25	2.00	2.125	16.50	6.000	6.00	5.63-13.63	5.25-6.75
2516K	12.88	12.50	14.50-13.25	1.69	2.380	16.75	6.000	6.00	5.50-13.50	5.13-6.63
2517K	14.00	13.50	14.00-15.00	2.25	1.750	16.50	6.000	6.00	5.63-13.63	6.00-7.50
2518K	15.00	14.50	15.25-16.25	2.00	2.750	16.50	6.000	6.00	5.63-13.63	6.50-8.00
2519K	15.75	15.75	16.38-17.38	2.25	2.500	16.63	6.000	6.00	5.63-13.63	7.00-8.50
2520K	17.00	16.00	17.25-18.25	2.25	2.625	16.50	6.000	6.00	5.63-13.63	7.50-9.00

All listed measurements are in inches.

CLINICAL

- Designed for the client who has minimal to moderate postural needs and who requires a taller trunk support.
- Suitable also for the client who may have changing postural needs over time.
- Provides excellent posterior pelvis stabilization and posterior thoracic support, facilitating thoracic extension.
- Can also address the needs of the client with skin integrity issues on the spinous processes.

TECHNICAL

- Tall, lightweight, contoured aluminum shell and contoured foam insert.
- Angle adjustability of up to 15°.
- Optional spinal fluid pad insert provides pressure and shear reduction.
- AirExchange™ cover encourages ventilation to keep the body cool.
- Height adjustable.
- Angle adjustable up to 15°.
- Creates minimal loss of seat depth.
- Shape and size minimizes interference with upper extremity functional activities.
- Lightweight and easily removed for transportation.

- Provides mild to more aggressive lateral support.
- Optional fixed or swing-away trunk supports ideal for correcting or accommodating a mild to moderate asymmetrical posture.
- Optional fixed or swing-away trunk supports also ideal for providing symmetrical lateral support.

- Extended and offset hardware kits are available for a custom fit.
- Flat and curved pads available.
- Fluid pads available for the client with skin integrity issues.

Jay J2 Tall

THORACIC



SADMERC Code: E2613

Includes a back shell, foam back with AirExchange™ cover, two lumbar shims and universal mounting hardware.

LATERAL



SIDE VIEW - RECLINED



FRONT VIEW

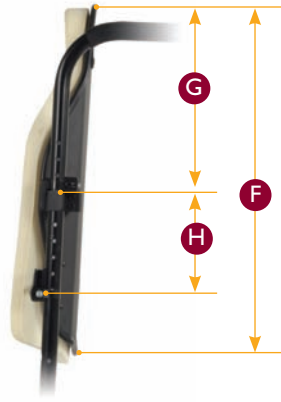

SIDE VIEW

Effects to seat depth with relation to recline (standard hooks).

	L	M	N
-3°	.13	1.00	
0°	.73	.78	
3°	1.33	.55	
6°	1.93	.33	
9°	2.53	.10	
12°	3.13	-.13	

Effects to seat depth with relation to recline (long hooks).

	L	M	N
7°	3.38	-.13	
10°	4.08	-.40	
13°	4.78	-.68	
16°	5.48	-.95	
19°	6.18	-1.23	
22°	6.88	-1.50	

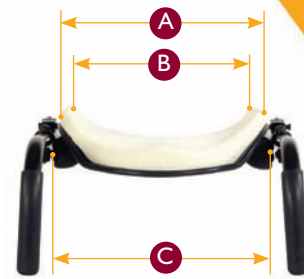

TOP VIEW

PART #	OUTSIDE WIDTH OF SHELL	WIDTH OF SUPPORT SURFACE	ATTACHING WIDTH OF CHAIRS	UPPER CONTOUR DEPTH OF BACK	LOWER CONTOUR DEPTH OF BACK	HEIGHT OF BACK SHELL	UPPER ATTACHMENT POINT	LOWER ATTACHMENT POINT	VERTICAL LATERAL SUPPORT POSITION	HORIZONTAL LATERAL SUPPORT POSITION
	A	B	C	D	E	F	G	H	J	K
2514TK	10.88	10.50	11.13-12.38	1.75	2.75	21.00	11.50	5.25	7.63-17.63	4.25-5.75
2515TK	12.00	11.75	12.13-13.38	1.50	1.25	23.00	12.38	5.88	5.63-19.63	5.25-6.75
2516TK	12.75	12.50	14.50-13.25	1.50	2.50	23.13	12.38	5.88	7.63-19.63	5.25-6.75
2517TK	14.00	13.75	14.25-15.50	1.50	1.25	23.00	12.38	5.88	7.63-16.63	6.25-7.75
2518TK	15.00	14.00	15.25-16.50	1.75	2.50	23.00	12.50	5.88	7.63-19.63	6.25-7.75
2519TK	15.88	15.50	16.38-17.63	1.50	2.00	23.00	12.38	5.88	7.63-16.63	7.00-8.50
2520TK	17.00	16.00	17.25-18.50	2.00	1.75	23.00	12.50	5.88	7.63-19.63	6.75-8.25

All listed measurements are in inches.

Jay J2 Deep Contour



SADMERC Code: E2615

1 Adjustable lateral support shims gently hug the body for increased trunk stability.

2 Adjustable posterior/lateral pelvic support shims help stabilize the pelvis laterally and contour the foam.

3 Adjustable posterior pelvic support contours the foam and positions the pelvis. Long, short or offset hook options for optimum fit to wheelchair.

Includes a deep aluminum back shell, a deep contour foam back with an AirExchange™ cover, two lateral support wedges, two posterior pelvic supports, and universal mounting hardware.

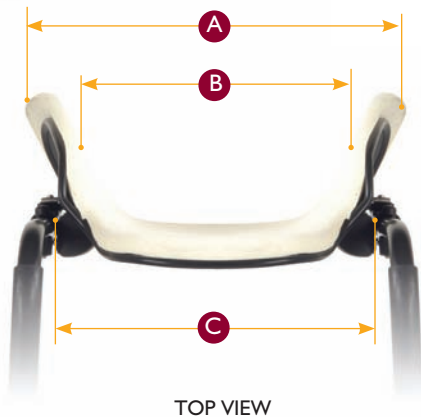

TOP VIEW



SIDE VIEW

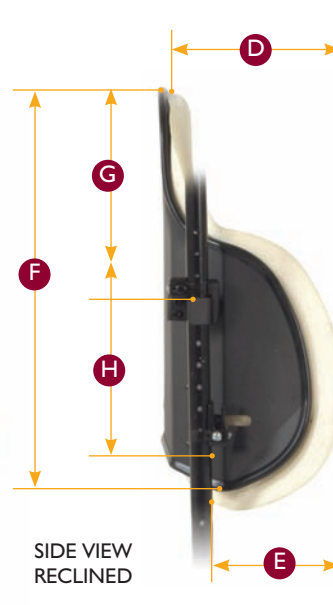

SIDE VIEW RECLINED

Effects to seat depth with relation to recline (standard hooks).

L	M	N
-3°	1.00	1.00
0°	1.55	.86
3°	2.10	.76
6°	2.65	.55
9°	3.20	.40
12°	3.75	.29

Effects to seat depth with relation to recline (long hooks).

L	M	N
7°	3.50	.38
10°	4.13	.33
13°	4.75	.28
16°	5.38	.23
19°	6.00	.18
22°	6.63	.13

CLINICAL

- Designed for the client who has moderate postural needs.
- Suitable for the client who needs a lightweight, easy-to-use back support that provides both pelvic and trunk positioning.
- Suitable for the client who has changing postural needs over time.
- Provides excellent posterior pelvis stabilization and posterior thoracic support, facilitating thoracic extension.
- Addresses the needs of the client with skin integrity issues on the spinous process.
- Facilitates efficient wheelchair propulsion.
- Back angle is adjustable to facilitate visual orientation.

TECHNICAL

- Lightweight, contoured aluminum shell, contoured foam insert and optional posterior– lateral pelvic supports provide exceptional pelvic and trunk support.
- Angle adjustability of up to 15°.
- Optional spinal fluid pad insert provides pressure and shear reduction.
- Height adjustable.
- Shape and size minimizes interference with upper extremity functional activities.
- Extended and offset hardware kits are available to allow for a custom fit.
- A personalized fit is easy with positioning accessories that attach with Velcro®.
- Easy installation and simple fittings.
- Does not compromise seat depth.

THORACIC

LATERAL

- Provides moderate to more aggressive lateral support.
- Most suitable for the person with decreased lateral trunk stability.

- Deep lateral walls provide excellent lateral trunk stability.
- Foam wedges provide opportunity for a more customized fit.
- Posterior lateral pelvic positioning can be customized through the use of positioning accessories.

PART #	OUTSIDE WIDTH OF SHELL	WIDTH OF SUPPORT SURFACE	ATTACHING WIDTH FOR CHAIRS	UPPER CONTOUR DEPTH OF BACK	LOWER CONTOUR DEPTH OF BACK	HEIGHT OF BACK SHELL	UPPER ATTACHMENT POINT	LOWER ATTACHMENT POINT
	A	B	C	D	E	F	G	H
2314	14.50	9.00	11.75-13.0	6.00	6.25	17.25	8.00	6
2315	15.50	10.25	12.75-14.0	5.50	6.00	18.50	9.00	6
2316	16.50	11.75	11.50-13.5	6.13	7.00	18.50	9.13	6
2317	17.25	12.00	14.75-16.0	7.00	6.50	18.25	9.00	6
2318	18.25	13.00	15.75-17.0	7.00	6.50	18.00	9.00	6
2319	19.00	14.00	16.75-18.0	7.00	6.50	18.00	9.00	6
2320	20.00	15.25	17.75-19.0	7.00	6.75	18.00	9.00	6

Jay Focus Point



SADMERC Code: E2615

Three piece design includes a back shell, two adjustable lateral wings, foam pelvic wedge, universal headrest mounting plate and clamp.

THORACIC

LATERAL

CLINICAL

- Designed for the client who has moderate to high postural needs
- Suitable for the client who needs an easy-to-use back support that provides both posterior pelvic and lateral positioning.
- Ideal for the client who has changing postural needs over time.
- Scapular cut-outs minimize interference with upper extremity range of motion.

TECHNICAL

- Three piece contoured design features a rib reinforced contoured aluminum shell and two multi-adjustable lateral wings.
- Features a universal mounting plate for headrests as a standard option
- Back Height Adjustment: 4"
- Width adjustment: 1"
- Seat Depth: 1.8"
- Back Angle: Recline Angle: 20° forward, 45° backward
- Clamp style hardware fits on 1" and 7/8" back canes.
- Easy Installation and adjustments for a customized fit.
- Contoured foam attached to the cover features a pelvic wedge that can be placed in multiple positions for posterior pelvic support

- Provides moderate to aggressive lateral support.
- Most suitable for the person with decreased lateral trunk stability symmetrical lateral support.

- Lateral wing adjustments:
 - Height: 4" (1" increments)
 - Width: 1-1.5"
 - Horizontal angle: up to 127°*

*Horizontal angle may be limited by wheelchair configuration.



PART NUMBER	FITS CHAIR SIZE	WIDTH OF SUPPORT SURFACE	CONTOUR DEPTH	BACK DEPTH ADJUSTMENT	HEIGHT OF BACK SHELL	UPPER ATTACHMENT POINT	HARDWARE HEIGHT	WIDTH BETWEEN LATERAL SUPPORTS*	LATERAL HEIGHT
	A	B	C	D	E	F	G	H	I
FPB1415T	14 - 15	9.0	7.2	+ .5/ - 1.3	17.0	7.4 - 9.4	4.8	9.7 - 13.8	8.0
FPB1415	14 - 15	9.0	7.2	+ .5/ - 1.3	14.0	4.4 - 6.4	4.8	9.7 - 13.8	8.0
FPB1617T	16 - 17	11.0	7.7	+ .5/ - 1.3	18.0	6.4 - 9.4	4.8	11.7 - 15.8	8.6
FPB1617	16 - 17	11.0	7.7	+ .5/ - 1.3	15.0	3.4 - 6.4	4.8	11.7 - 15.8	8.6
FPB1819T	18 - 19	13.0	8.2	+ .5/ - 1.3	19.0	7.4 - 10.4	4.8	13.7 - 17.8	9.0
FPB1819	18 - 19	13.0	8.2	+ .5/ - 1.3	16.0	4.4 - 7.4	4.8	13.7 - 17.8	9.0
FPB2021T	20 - 21	15.0	8.6	+ .5/ - 1.3	20.0	7.4 - 11.4	4.8	15.7 - 19.8	9.3
FPB2021	20 - 21	15.0	8.6	+ .5/ - 1.3	17.0	4.4 - 8.4	4.8	15.7 - 19.8	9.3

All listed measurements are in inches.

*Measured when lateral was at 90° angle.

Jay J2 Plus



SADMERC Code: E2614

To order the headrest mounting kit add an "AH" at the end of the part number. To order the mounting hardware for 0° or 8° add a -0 or -8 to the part number.

THORACIC

LATERAL

CLINICAL

- ▶ Weight capacity 650 lbs.- primarily designed for the bariatric client.
- ▶ A bi-angular back that provides excellent pelvic and trunk stability.
- ▶ Trunk and pelvic stability encourages extremity function.
- ▶ Facilitates efficient wheelchair propulsion.
- ▶ Back angle is adjustable to facilitate visual orientation.

TECHNICAL

- ▶ Anatomically aligned bi-angular components allow control of pelvis-to-trunk angles.
- ▶ 15° angle adjustability facilitates trunk extension for optimal postural stability.
- ▶ Adjustable vanity flap locks into place once pelvic stability is optimized.
- ▶ Centerline recess accommodates natural contour for spinal column, decreasing the risk of bottoming out and reducing skin redness.
- ▶ Optional spinal fluid pad insert reduces the effects of shear and pressure.
- ▶ AirExchange™ cover with spacer-fabric lining encourages ventilation to keep the body cool.
- ▶ With two back shells covering widths of 20"- 23" and 23"- 26", the size of a client is easily accommodated.
- ▶ Seat depth is not compromised.

- ▶ Optional lateral supports provide lateral trunk stability.

Effects to seat depth with relation to recline.

L	M
-3°	.88
0°	1.53
3°	2.18
6°	2.83
9°	3.48
12°	4.13

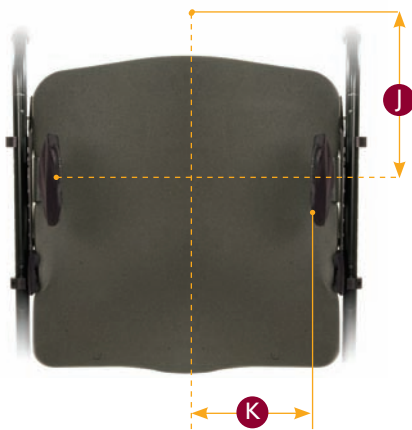

FRONT VIEW



SIDE VIEW RECLINED

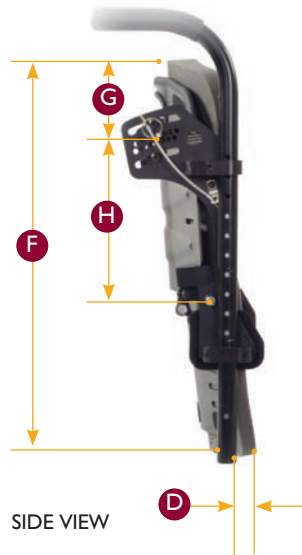

SIDE VIEW

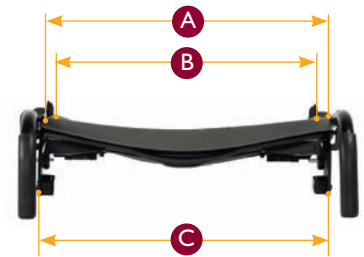

TOP VIEW

PART #	OUTSIDE WIDTH OF SHELL	WIDTH OF SUPPORT SURFACE	ATTACHING WIDTH FOR CHAIRS	CONTOUR DEPTH OF BACK	HEIGHT OF BACK SHELL	UPPER ATTACHMENT POINT	LOWER ATTACHMENT POINT	VERTICAL LATERAL SUPPORT POSITION	HORIZONTAL LATERAL SUPPORT POSITION
	A	B	C	D	F	G	H	J	K
202023A	17.50	17.50	20.63-17.25	2.38	19.88	3.5	8.75	5.00-8.00	8.0-7.0
202326A	20.25	21.00	24.00-21.00	2.38	20.00	3.5	8.75	5.25-8.00	11.0-9.0

All listed measurements are in inches.



Jay Xtreme

Includes an aluminum back shell, foam back cushion, Tritex™ cover, and height adjustable permanent mount hardware.

SADMERC Code K0669

PART #	CHAIR SIZE
--------	------------

1913	13
1914	14
1915	15
1916	16
1917	17
1918	18

Jay Protector



Fluid-filled Cushion

Helps reduce pressure and shear

Concealed Molded Foam Base

Absorbs impact and assists in stable sitting.

Waterproof

For bath or boating.

Easy Snap Buckles

For attachment at waist and legs.

Durable Nylon Ballistic Cloth

Won't puncture on sharp surfaces.

PART #	PRODUCT
--------	---------

141	Adult Cushion
142	Adult Sling
144	Jr. Cushion
145	Jr. Sling

Jay Solid Seat



The Jay® Adjustable Solid Seat improves posture by providing a firm, fully-adjustable base of support.

Includes a solid seat with non-skid surface and hardware for mounting on wheelchair.

PART #	CHAIR SIZE
--------	------------

270	Solid seat 15-18" x 12-18"
270.1	Adjusts 15-18" width 2.5" Drop option
270.1L	Adjusts 15-18" width 2.5" Drop Seat, Lip Kit
270L	Adjustable Solid Seat with Lip Kit
271	Solid seat adjusts 10-11" x 10-12"
271.1	Adjusts 10-11" width 2.5" Drop option
271.1L	Adjusts 10-11" width 2.5" Drop Seat, Lip Kit
271L	10" adjustable solid seat with lip kit
272	Solid seat 11.5"-14.5" x 10-16"
272.1	Adjusts 11.5-14.5" width 2.5", drop option
272.1L	Adjusts 11.5-14.5" width 2.5" drop option, lip kit
272L	Adjustable Solid Seat with Lip Kit
273.1	Adjusts 18.5"-22" x 12"-20"
273.1L	Large solid seat with lip kit

Jay Precision

SADMERC Code: K0108
Misc. Wheelchair Accessory



THORACIC

- ▶ Designed for the client who has mild or changing postural needs.
- ▶ Provides posterior pelvic stabilization and posterior thoracic support, facilitating thoracic extension and or thoracic flexion (Kyphosis).
- ▶ Can accommodate mild symmetrical and asymmetrical orthopedic deformities.
- ▶ Maintains the convenience of a folding back support.
- ▶ Convenient, lightweight and easy to fold tension adjustable back support.
- ▶ Depth adjustable.
- ▶ Spinal support adjustments made with non-Velcro® strapping.
- ▶ Shape and size minimizes interference with upper extremity functional activities.
- ▶ Optional stabilizer bar supports a headrest that folds with the chair.
- ▶ Back post cover can interface with towel bars.

LATERAL

- ▶ Provides mild to moderate lateral support.
- ▶ Optional fixed or swing-away lateral supports ideal for correcting or supporting asymmetrical or symmetrical posture.
- ▶ Asymmetrical and symmetrical options available.
- ▶ Fixed or swing-away.

Jay Precision available in the following configurations:

Sizes: 12" - 20" wide X Medium (11") or Tall (16")

Laterals: Symmetrical / Asymmetrical, Swing -Away / Fixed (Omit)

Folding Stabilizer Bar / Folding Stabilizer Bar with Headrest

Back Accessories and Specs

	Xtreme	J2	Care	J2 Deep Contour	J2 Tall	J2 Plus	Jay Precision	
MISCELLANEOUS:								
• Pelvic/Lumbar Supports (PSIS Foam)		•		•	•	•		
• Lateral Support Adj Wedges			•	•				
• Swing Away Lateral Trunk Supports		•			•		•	
• Lateral Trunk Supports		•		•	•	•	•	
• Posterior Lateral Pelvic/Lumbar Supports				•		•		
• Fluid Spinal Insert		•		•	•	•		
• Bottom Universal Post Bracket		•	•	•	•			
• Top Quick Release 1/4 turn bracket		•	•	•	•			
• Extended Hardware Kit		•	•	•	•			
• Long Strap Kit		•	•	•	•			
• Back Wedge								
• Soft Elastomers	•							
• Firm Elastomers	•							
• Quick Release Brackets		•			•			
• Universal Headrest Plate		•		•	•	•		
• Growth Plates						•		
MOUNTING HARDWARE :								
• Offset hooks and pins		•	•	•	•	•		
• Long hooks		•	•	•	•	•		
COVERS:								
• Stretch			•					
• Tritex	•							
• Air Exchange™		•		•	•	•		
• Hood				•				
• Wrap Around		•			•			
• Custom	•	•	•	•	•	•	•	
User Weight Capacity (lbs.)	250	250	250	250	250	650	250	
Warranty (years)	2	2	2	2	2	2	2	

Back Size Matrix

	J2	J2Tall	J2DC	Width Setting	Narrowest Setting	Widest	½"Offset Hook	1"Offset Hook
Short hooks often used with angled backpost.	2512K	2512TK	N/A	12" wide	11	12.5	13.5	14.5
	2513K	2513TK	N/A	13" wide	12	13.5	14.5	15.5
	2514K	2514TK	2314	14" wide	13	14.5	15.5	16.5
Long hooks more common with straight backpost	2515K	2515TK	2315	15" wide	14	15.5	16.5	17.5
	2516K	2516TK	2316	16" wide	15	16.5	17.5	18.5
	2517K	2517TK	2317	17" wide	16	17.5	18.5	19.5
	2518K	2518TK	2318	18" wide	17	18.5	19.5	20.5
	2519K	2519TK	2319	19" wide	18	19.5	20.5	N/A
	2520K	2520TK	2320	20" wide	19	20.5	N/A	N/A

Additional support materials by JAY to meet your seating needs

Pelvic & Spinal Postures

CLINICAL ISSUES

POSTERIOR PELVIC TILT

PELVIC OBLIQUITY

PELVIC ROTATION

ANTERIOR PELVIC TILT

THORACIC KYPHOSIS

THORACIC

Seating & Wheelchair Angles

PELVIS TO THIGH

THIGH TO LOWER LEG

LOWER LEG TO FOOT

Backs & Cushions

PELVIS & SPINE

JAY RETAIL PRICE LIST

SUNRISE MEDICAL

Improving People's Lives

0256

0257

0104

0254

0255



www.sunrisemedical.com

800.333.4000
800.263.3390 in Canada